



---

## AM/FM STEREO SHOWER RADIO AND CD PLAYER



### USER MANUAL

**JCR-525**

**PLEASE READ THIS USER MANUAL COMPLETELY BEFORE OPERATING THIS UNIT AND RETAIN THIS BOOKLET FOR FUTURE REFERENCE.**

## DEAR JENSEN® CUSTOMER

Selecting fine audio equipment such as the unit you've just purchased is only the start of your musical enjoyment. Now it's time to consider how you can maximize the fun and excitement your equipment offers. This manufacturer and the Electronic Industries Association's Consumer Electronics Group want you to get the most out of your equipment by playing it at a safe level. One that lets the sound come through loud and clear without annoying blaring or distortion and, most importantly, without affecting your sensitive hearing.

Sound can be deceiving. Over time your hearing "comfort level" adapts to higher volumes of sound. So what sounds "normal" can actually be loud and harmful to your hearing. Guard against this by setting your equipment at a safe level BEFORE your hearing adapts.

### To establish a safe level:

- Start your volume control at a low setting.
- Slowly increase the sound until you can hear it comfortably and clearly, and without distortion.

### Once you have established a comfortable sound level:

- Set the dial and leave it there.
- Taking a minute to do this now will help to prevent hearing damage or loss in the future. After all, we want you listening for a lifetime.

### We Want You Listening For a Lifetime

Used wisely, your new sound equipment will provide a lifetime of fun and enjoyment. Since hearing damage from loud noise is often undetectable until it is too late, this manufacturer and the Electronic Industries Association's Consumer Electronics Group recommend you avoid prolonged exposure to excessive noise.



### Customer's Record:

The serial number of this product is found on its bottom cover. You should note the serial number of this unit in the space provided as a permanent record of your purchase to aid in identification in the event of theft or loss.

Model Number: JCR-525

Serial Number: \_\_\_\_\_

## IMPORTANT SAFETY INSTRUCTIONS

When used in the directed manner, this unit has been designed and manufactured to ensure your personal safety. However, improper use can result in potential electrical shock or fire hazards. Please read all safety and operating instructions carefully before installation and use, and keep these instructions handy for future reference. Take special note of all warnings listed in these instructions and on the unit.

1. Read these instructions – All the safety and operating instructions should be read before the appliance is operated.
2. Keep these instructions – The safety and operating instructions should be kept for future reference.
3. Heed all warnings – All warnings on the appliance and in the operating instructions should be adhered to.
4. Follow all instructions – All operation and use instructions should be followed.
5. Clean only with dry cloth – The appliance should be cleaned only as recommended by the manufacturer.
6. Do not install near any heat sources such as radiators, heat registers, stoves, or other apparatus (including amplifiers) that produce heat.
7. Only use attachments / accessories specified by the manufacturer.
8. Unplug this apparatus during lightning storms or when unused for long periods of time.
9. Refer all servicing to qualified service personnel. Servicing is required when the apparatus has been damaged in any way, such as power-supply cord or plug is damaged, liquid has been spilled or objects have fallen into the apparatus, the apparatus has been exposed to rain or moisture, does not operate normally, or has been dropped.
10. Power Sources – The appliance should be connected to a power supply only of the type described in the operating instructions or as marked on the appliance. Do not overload wall outlet.
11. Do not attempt to dismantle, open or repair this product yourself. If a fault occurs, seek advice from your local qualified service technician or contact the distributor via the telephone number at the back of this instruction manual.
12. Caution marking and nameplate are located on back of product.
13. Battery shall not be exposed to excessive heat such as sunshine, fire or the like.
14. **CAUTION**  
Danger of explosion if battery is incorrectly replaced.  
Replace only with the same or equivalent type.

## COMPLIANCE WITH FCC REGULATIONS

This device complies with Part 15 of the FCC Rules. Operation is subject to the following two conditions:

- (1) this device may not cause harmful interference, and
- (2) this device must accept any interference received, including interference that may cause undesired operation.

NOTE : This equipment has been tested and found to comply with the limits for a Class B digital device, pursuant to Part 15 of the FCC Rules. These limits are designed to provide reasonable protection against harmful interference in a residential installation. This equipment generates, uses and can radiate radio frequency energy and, if not installed and used in accordance with the instructions, may cause harmful interference to radio communications. However, there is no guarantee that interference will not occur in a particular installation. If this equipment does cause harmful interference to radio or television reception, which can be determined by turning the equipment off and on, the user is encouraged to try to correct the interference by one or more of the following measures:

- Reorient or relocate the receiving antenna.
- Increase the separation between the equipment and receiver.
- Connect the equipment into an outlet on a circuit different from that to which the receiver is connected.
- Consult the dealer or an experienced radio/TV technician for help.

**CAUTION: Changes or modifications not expressly approved by the party responsible for compliance could void the user's authority to operate the equipment.**

## **SAVE THESE INSTRUCTIONS**

### **IMPORTANT NOTE:**

Avoid installing the unit in locations described below:

- Places exposed to direct sunlight or close to heat radiating appliances such as electric heaters.
- Places subject to constant vibration.
- Sources of electrical noise such as fluorescent lamps or motors.
- In case of malfunction due to electrostatic discharge, the apparatus has to be reset by disconnecting it from mains supply and removing all the batteries. Wait at least for 60 seconds before reconnect the AC power cord or reinstall the batter

## **CAUTION**

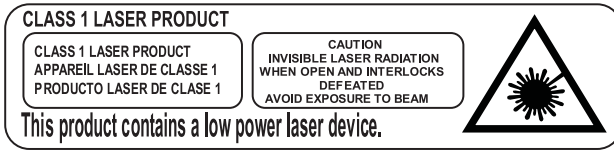

**Note:** This product complies with DHHS Rule 21 Subchapter J at date of manufacture. Follow the advice below for safe operations.

### **ON PROTECTION AGAINST LASER ENERGY EXPOSURE**

- As the laser beam used in this compact disc player is harmful to the eyes, do not attempt to disassemble the casing.
- Stop operation immediately if any liquid or solid object should fall into the cabinet.
- Do not touch the lens or poke at it. If you do, you may damage the lens and the player may not operate properly.
- Do not put anything in the safety slot. If you do, the laser diode will be ON when the CD door is still open.
- If the unit is not to be used for a long period of time, make sure that all power sources are disconnected from the unit. Remove all batteries from the battery compartment, and unplug the AC-DC adaptor from the wall outlet. Make it a practice to remove the AC-DC adaptor by grasping the main body and not by pulling the cord.
- This unit employs a laser. The use of controls or adjustment or performance of procedures other than those specified here may result in exposure to hazardous radiation.
- Should any trouble occurs, remove the power source and refer servicing to qualified personnel.

## **PROTECT YOUR FURNITURE!!**

This system is equipped with non-skid rubber 'feet' to prevent the product from moving when you operate the controls. These 'feet' are made from non-migrating rubber material specially formulated to avoid leaving any marks or stains on your furniture. However certain types of oil based furniture polishes, wood preservatives, or cleaning sprays may cause the rubber 'feet' to soften, and leave marks or a rubber residue on the furniture.

To prevent any damage to your furniture we strongly recommend that you purchase small self-adhesive felt pads, available at hardware stores and home improvement centers everywhere, and apply these pads to the bottom of the rubber 'feet' before you place the product on fine wooden furniture.

### **CAUTION ON SPLASH RESISTANT:**

This unit has been constructed to resist mild steam and light splashes from the shower or bath only. It should not be operated under running water and under no circumstances should it be fully immersed in water.

## INSTALLATION

The JCR-525 can be placed on a counter or hung from your shower head, shower curtain rod or from a hook attached to the wall or door.

## USING THE STAND

### ATTACHING / REMOVING THE STAND

To use this unit with the supplied stand, place the unit onto the STAND as shown in the illustration below. Make sure the square hole in the bottom of the unit is placed onto the hook located on the base. Gently push the unit backward so it locks in place. A "Click" will be heard to confirm the base is attached.

To remove the unit from the STAND, pull down on the locking tab located on the back of the base as shown in the illustration below to unlock the unit from the base. The unit can now be removed from the base.

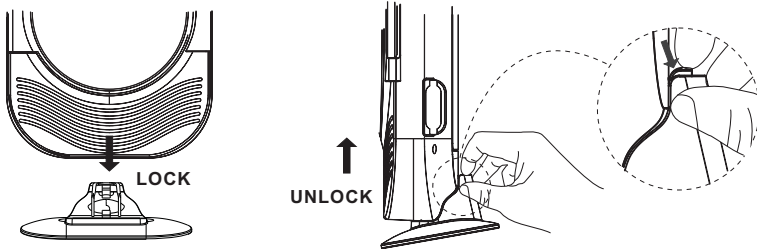

## PLACEMENT OF YOUR RADIO

The JCR-525 is equipped with a detachable hanger rope that allows you to hang the radio from your shower head, shower curtain rod or from a hook on the back of the bathroom door.

### ATTACHING THE ROPE HANGER BRACKET



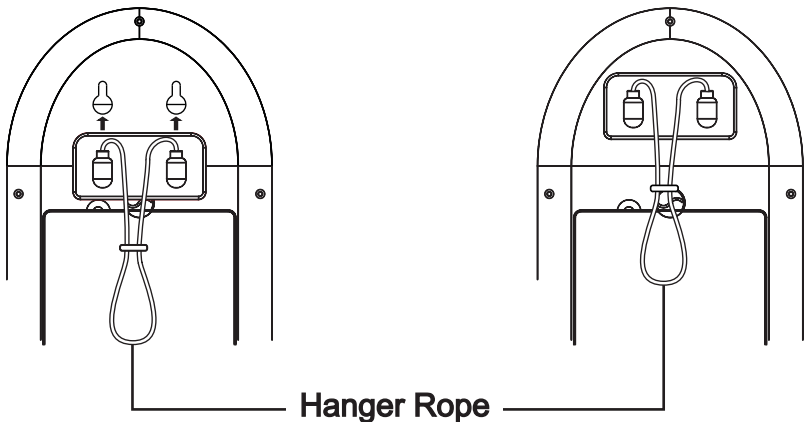



Attach the Rope Hanger Bracket to the back of the unit as shown in the illustration below

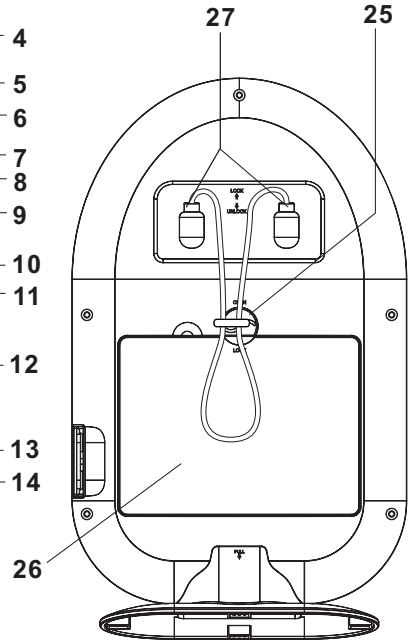
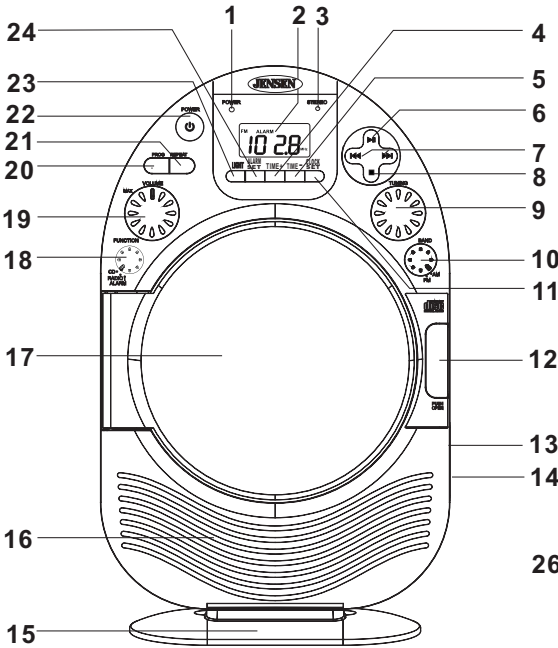

Front Side

Rear Side



1. POWER Indicator	15. Detachable Stand
2. LCD Display	16. SPEAKER
3. FM STEREO Indicator	17. CD LID & MIRROR
4. TIME - Button	18. FUNCTION Selector
5. TIME + Button	19. VOLUME Control Knob
6. CD PLAY/PAUSE  Button	20. PROGRAM Button
7. CD SKIP/SEARCH FORWARD  Button CD SKIP/ SEARCH BACKWARD  Button	21. REPEAT Button
8. CD STOP  Button	22. POWER ON/Standby  Button
9. TUNING Control Knob	23. Blue Backlight ON/OFF Button
10. AM/FM Band Selector	24. ALARM SET Button
11. CLOCK SET Button	25. Rotary Lock
12. CD DOOR OPEN Button	26. Battery Door
13. Earbud Jack	27. Hanger Hole
14. DC INPUT Jack (DC 9V  )	

## POWER SOURCE

The JCR-525 operates on 6 X 'C' size (UM-2) batteries (not included) or with an external AC-DC adaptor (not included) with a rating of DC 9V, 1000mA . The battery backup for the clock operates on two 'AAA' batteries (not included).

### A. BATTERY OPERATION

For best performance and longer operating time, we recommend the use of good quality alkaline batteries.

1. Open the Battery Door by rotating the lock so the mark is pointing to the "OPEN" index mark located on the cabinet. A "Click" will be heard and you can now remove the door.
2. Following the polarity (+ and -) diagram shown inside the battery compartment, first insert two 'AAA' size (UM-4) battery in the smaller compartment and then the 6 X 'C' size (UM-2) batteries.

**IMPORTANT:** Be sure that the batteries are installed correctly. Wrong polarity may damage the unit and void the warranty.

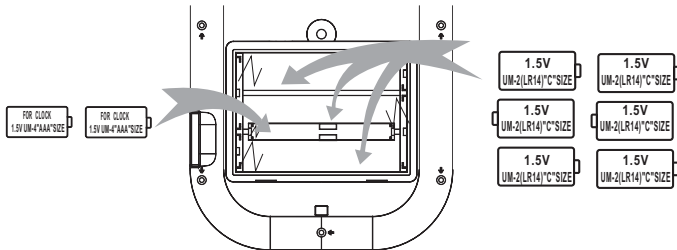

3. Replace the Battery Door and rotating the lock so the mark is pointing to the "LOCK" index mark located on the battery door. A "Click" will be heard and the door is now secure.
4. After prolonged use, the battery voltage may discharge to such a low level that the unit will not work properly. In that case, you need to replace them all at once with fresh good quality batteries. Remove all exhausted batteries and follow above procedures to replace new batteries.

### ⚠ BATTERY NOTE AND CARE

- Danger of explosion if the battery is replaced incorrectly. Replace only with the same type battery.
- Do not mix old and new batteries.
- Do not mix alkaline, standard (carbon-zinc) or rechargeable (nickel-cadmium) batteries.
- If the unit is not to be used for an extended period of time, remove the batteries. An old or leaking battery can cause damage to the unit and may void the warranty.
- Do not try to recharge batteries not intended to be recharged, they can overheat and rupture. (Follow battery manufacturer's directions.)
- Do not dispose of batteries in fire, batteries may explode or leak.
- Only an adult should replace the batteries.

### B. AC OPERATION

The JCR-525 will also operate using an AC-DC adaptor (not included). When the AC-DC adaptor is connected to the DC Jack the batteries are automatically disconnected. Be sure to use an AC-DC adaptor with a rating of DC 9V, 1000 mA and with the following polarity:

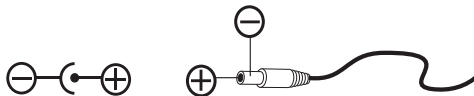

If you are using a universal adaptor with an output polarity switch or polarized plugs, be sure to set the polarity of the center plug to "+".

**WARNING:** Never use this radio near water or in the shower when using an AC Adaptor. Shock or personal injury could occur.

## SETTING THE TIME

In order for the clock to function properly, the clock has to be set before you use it for the first time. After powering up the unit, the clock display will show “12:00”. To set the time, follow the steps below:

1. Press and hold the CLOCK SET Button. Hour digits are flashing to prompt for input.
2. Tap the TIME +/- Buttons repeatedly and release until the correct hour is displayed.



**Note:** Make sure the hour is set so that AM or PM is correctly displayed.

There is a **PM** Indicator located in the upper left corner of the LCD

display. If the PM Indicator is showing on the display, the displayed time is “PM”. If the PM Indicator is not showing on the display, the time displayed is “AM”.

3. Press the CLOCK SET Button to confirm the hour setting. The Minute digits are flashing to prompt for input.
4. Tap the TIME +/- Buttons repeatedly until the correct minutes are displayed.
5. Tap the CLOCK SET button to finish the set-up.

## RADIO OPERATION

1. Set the Function Selector to “RADIO” position and the BAND Selector to “AM” or “FM” for the desired radio band.
2. Press the  Button to turn the unit on. The POWER Indicator will light.
3. Tune to your desired station with the TUNING Control knob. If FM mode is selected and you tune to an FM Stereo station, the FM STEREO Indicator will light.
4. Adjust the VOLUME Control to obtain the desired sound level.
5. To turn the Radio OFF, press the  Button. The POWER Indicator goes off.

### TIPS FOR BEST RADIO RECEPTION







The unit has built-in FM and AM antenna. To obtain the best radio reception, you may have to move or slightly rotate the unit.



## CD PLAYER OPERATION

**Note:** This CD player will play not only commercial CDs, but also the self-compiled CD-R/RW discs. Do not attempt to play CD-ROM, CDI, VCD, DVD or computer CDs.











### Notes on CD-R/RW Discs

- Because of non-standardized format definition/production of CD-R/RW, playback quality & performance are not guaranteed.
  - Manufacturer is not responsible for the playability of CD-R/RW due to recording conditions such as PC performance, writing software, media ability, etc.
  - Do not attach a label or seal to either side of the CD-R/RW disc. It may cause a malfunction.
1. Set the Function Selector to the "CD" position.
  2. Press the  Button to turn on the unit, the POWER Indicator will light. "- ." will appear and flash in the Display. After a few seconds, "no" will appear in the display if no disc is loaded.
  3. Press the PUSH OPEN Button to open the CD Door.
  4. Load an audio CD with its label side facing out and close the CD Door. A click sound will be heard indicating the CD Door is firmly locked.
  5. "- ." will appear and blink in the Display. After a few seconds, Track No. "01" will be shown steadily in the Display and that CD will auto playback.
  6. To pause playback, press the  Button. The Track No. "01" will flash. To resume playing, press the  Button again.
  7. Adjust the VOLUME Control to obtain the desired sound level from the Speakers.
  8. You can choose to play your favorite track directly by pressing the Skip Forward  Button to skip forward or the Skip Back  Button to skip backward. The track number of the selected track will be shown in the Display.
  9. To repeat the current track that is playing, press the REPEAT Button until "REP 1" icon appears in the top right corner of the Display.
  10. To repeat the entire CD, press the REPEAT Button until "REP ALL" icon appears in the top right corner of the Display. Press the REPEAT Button again to resume normal playback.
  11. To stop playing, press the STOP  Button.



### CD PROGRAMMED PLAY

This function allows your favorite tracks to be played in a programmed sequence.

1. Set the Function Selector to the "CD" position and press the  Button to turn the unit on.
2. Open the CD Door, insert an audio CD and press the STOP button, total number of tracks on the CD will be displayed.
3. Press the PROG Button once. Program No, "P01", will be shown briefly and then changes to Track No. "00" and flash together with the Program Indicator, "PROG", in the Display.
4. Press the  or  Buttons to select the song to be programmed.
5. Press the PROG Button again to store your selection. Program No. "P02" will be shown briefly and resume to "00" and flash to prompt for another input.
6. Press the  or  Buttons to select the next song to be programmed and press the Program Button again to store your second selection.
7. You may repeat above steps 3 - 5 to program as many as 20 tracks. If you attempt to program more than 20 tracks, the Display will display flashing "FU".
8. To check the programmed tracks, press the PROG Button repeatedly. The Display will first show the PROGRAM No. and then the programmed track number in the programmed sequence.
9. Press  Button to start programmed play.
  - After all the programmed tracks have been played the player stops but the program remains in the memory.
  - Press the **PROG** Button and then the  Button to begin programmed playback again.
10. To cancel the program play and resume to normal playback, press the STOP  button twice, "PROG" icon disappeared. Press the  Button to start normal play.
11. To stop playing, press the STOP  Button.
12. To turn the Player off, press the Power ON/Standby  Button, the POWER Indicator goes off.

### IMPORTANT

Always turn off the power when the unit is not in use in order to extend the battery life.

### SETTING THE ALARM TIME

1. With the unit in standby mode and the alarm off, press and hold the ALARM SET Button. "ALARM" icon is displayed flashing with hour digits to prompt for input. Tap the TIME +/- Buttons repeatedly and release until the correct hour is displayed.

**Note:** Make sure the hour is set so that AM or PM is correctly displayed. There is a **PM** Indicator located in the upper left corner of the LCD display. If the PM Indicator is showing on the display, the displayed time is "PM". If the PM Indicator is not showing on the display, the time displayed is "AM".

2. Press the ALARM SET button to confirm the hour setting, minute digits are flashing to prompt for input.
3. Tap the TIME +/- Buttons repeatedly until the correct hour is displayed.
4. Tap the ALARM SET button to finish alarm clock setting, "ALARM" icon keeps displaying.

### CHECKING THE ALARM TIME

Whenever you want to check the alarm time, simply tap the ALARM SET Button to turn off alarm and tap the button again to turn it ON. The "ALARM" icon appears. The Display will show the alarm time for few seconds and then return to the current time.

### WAKE TO RADIO

1. Set the FUNCTION Selector to "RADIO" and turn on the unit.
2. Select the band, station, and volume level that you wish to hear when the alarm comes 'On'.
3. Make sure the "ALARM" icon appears in display. If no, tap the ALARM SET button to turn it on.
4. The radio will turn 'On' at the selected wake up time for 30 minutes. "ALARM" icon will blink while the alarm sounds.
5. To stop the radio, press the  or ALARM SET button. The radio will stop but the alarm remains set and will turn the radio on again at the same time on the following day.
6. If you do not want the alarm to turn the radio on the following day, tap the ALARM SET button until "ALARM" icon disappears from display.

### WAKE TO CD

1. Load an audio CD into the CD compartment.
2. Set the FUNCTION Selector to the "CD" position and turn on the unit, CD will start playback.
3. Set volume level that you wish to hear when the alarm comes 'On'.
4. Make sure the "ALARM" icon appears in display. If no, tap the ALARM SET button to turn it on.
5. The CD player will turn 'On' at the selected wake up time for 30 minutes. "ALARM" icon will blink while the alarm sounds.

**Note:** Please make sure a playable audio CD is correctly loaded if you set Wake to CD, otherwise wake to CD alarm will not sound at the selected wake up time.

6. To stop the alarm, press the  or ALARM SET button. The alarm will stop but the alarm remains set and will turn the CD player on again at the same time on the following day.
7. If you do not want the alarm to turn the alarm on the following day, tap the ALARM button until "ALARM" icon disappears from display.

### WAKE TO BEEPING ALARM

1. Set the FUNCTION Selector to the "ALARM" position.
2. Make sure the "ALARM" icon appears in display. If no, tap the ALARM SET button to turn it on.
3. At the selected wake up time the beeping alarm will sound. "ALARM" icon will blink while the alarm sounds. The alarm will sound for 30 minutes.
4. If you want to listen to the radio or CD after wake up, switch the FUNCTION Selector to "RADIO" or "CD" position.
5. To stop the alarm, tap the  or ALARM SET button. The beeping alarm will stop but the alarm remains set and will turn the beeper on again at the same time on the following day.
6. If you do not want the alarm to turn the beeping alarm on the following day, tap the ALARM SET button until "ALARM" icon disappears from display.

## USING EARBUDS

Inserting the plug of your earbuds (not included) into the Earbud Jack will enable you to listen to the CD or Radio in private. When using earbuds, the Speakers will be disconnected automatically.

### READ THIS IMPORTANT INFORMATION BEFORE USING YOUR EARBUDS

1. Avoid extended play at very high volume as it may impair your hearing.
2. If you experience ringing in your ears, reduce the volume or shut off your unit.
3. Do not use while driving a motorized vehicle. This is dangerous and also illegal in some states.
4. Keep the volume at a reasonable level even if your headset is an open-air type designed to allow you to hear outside sounds. Please note excessively high volume may still block outside sounds.

## USE DISPLAY BACKLIGHT

Press the LIGHT Button repeatedly to turn blue LCD display back light ON/OFF.

## TIPS ON USING YOUR FOG-RESISTANT MIRROR

1. Never use alkaline (caustic), alcohol or other organic cleaning agents to clean the mirror surface since this will cause permanent damage to the mirror.
2. Never use an abrasive cloth or paper to clean the mirror surface. This may damage the surface and adversely affect the life of the fog-resistant coating.
3. The fog-resistant mirror is designed to minimize condensation on the surface under normal, warm shower conditions. However, under extremely or humid conditions, some condensation is unavoidable.
4. Should water condense on the mirror surface, clean it with a soft lint-free cloth only.

## CARE AND MAINTENANCE

1. Clean this unit with a damp (never wet) cloth. Solvents or detergents should never be used.
2. Avoid leaving this unit in direct sunlight or in hot or dusty places.
3. Keep your unit away from heating appliances and sources of electrical noise such as fluorescent lamps or motors.
4. If drop-outs or interruptions occur in the music during CD play, or if the CD fails to play at all, its bottom surface may require cleaning. Before playing, wipe the disc from the center outwards with a good soft cleaning cloth.
5. Your unit has rubber seals to minimize the risk of moisture getting inside. However, do not immerse it in water since permanent damage to the electrical and mechanical parts will result.
6. Always clean the outside of the cabinet thoroughly if it becomes wet with moisture or water splashes. This will help to prevent the internal parts of the unit from entry of water and possible moisture damage.



### Cleaning the Unit

- To prevent fire or shock hazard, disconnect your unit from the AC power source when cleaning.
- The finish on the unit may be cleaned with a dust cloth and cared for as other furniture. Use caution when cleaning and wiping the plastic parts.
- If the cabinet becomes dusty wipe it with a soft dry dust cloth. Do not use any wax or polish sprays on the cabinet.
- If the front panel becomes dirty or smudged with fingerprints it may be cleaned with a soft cloth slightly dampened with a mild soap and water solution. Never use abrasive cloths or polishes as these will damage the finish of your unit.

**CAUTION:** Never allow any water or other liquids to get inside the unit while cleaning.

## TROUBLESHOOTING GUIDE

If you experience difficulties in the use of this music system, please check the following or call 1-800-777-5331 for Customer Service.

Symptom	Possible Cause	Solution
The unit does not respond (no power).	No batteries installed or installed batteries are exhausted.	Install 6 X "C" batteries or replace the exhausted batteries.
	Wall outlet is not functioning.	Plug another device into the same outlet to confirm the outlet is working.
Noise or sound distorted on AM or FM broadcast.	Station not tuned properly for AM or FM.	Retune the AM or FM broadcast station. Reposition the unit until the best reception is obtained.
No AM or FM sound.	The unit is not in AM or FM function mode. Volume at minimum	Set FUNCTION selector to RADIO.  Increase volume
CD player will not play	Unit not in CD function mode. CD is installed incorrectly. If the CD is self-compiled, the media used may not be compatible with the player. Weak Batteries	Select CD function mode. Insert CD with label side up. Use better quality blank media and retest.  Replace all batteries.
CD skips while playing	Disc is dirty or scratched.	Wipe CD with clean cloth or use another disc.
Intermittent sound from CD Player	Dirty or defective disc Dirty pick up lens  Player is subject to excessive shock or vibration	Clean or replace the defective disc Use a CD-lens cleaning disc to clean the lens Relocate the player away from shock or vibration
Unit gets warm after extended play at high volume	This is normal.	Turn the unit off a period of time or lower volume.

## SPECIFICATIONS

### **Power Requirement**

Battery Operation: 6 X "C" (UM-2) Batteries or  
DC Input: DC 9V, 1000 mA

Backup Battery for Clock: 2 X "AAA" (UM-4)

### **Frequency Range**

Radio Band AM 520 – 1710 KHz  
FM 87.5 - 108 MHz



At Spectra, environmental and social responsibility is a core value of our business. We are dedicated to continuous implementation of responsible initiatives with an aim to conserve and maintain the environment through responsible recycling.

Please visit us at <http://www.spectraintl.com/green.htm> for more information on Spectra's green initiatives or to find a recycler in your area.

**90 DAY LIMITED WARRANTY AND SERVICE  
VALID IN THE U.S.A ONLY**

SPECTRA MERCHANDISING INTERNATIONAL, INC. warrants this unit to be free from defective materials or factory workmanship for a period of 90 days from the date of original customer purchase and provided the product is utilized within the U.S.A. This warranty is not assignable or transferable. Our obligation under this warranty is the repair or replacement of the defective unit or any part thereof, except batteries, when it is returned to the SPECTRA Service Department, accompanied by proof of the date of original consumer purchase, such as a duplicate copy of a sales receipt.

You must pay all shipping charges required to ship the product to SPECTRA for warranty service. If the product is repaired or replaced under warranty, the return charges will be at SPECTRA's expense. There are no other express warranties other than those stated herein.

This warranty is valid only in accordance with the conditions set forth below:

1. The warranty applies to the SPECTRA product only while:
  - a. It remains in the possession of the original purchaser and proof of purchase is demonstrated.
  - b. It has not been subjected to accident, misuse, abuse, improper service, usage outside the descriptions and warnings covered within the user manual or non-SPECTRA approved modifications.
  - c. Claims are made within the warranty period.
2. This warranty does not cover damage or equipment failure caused by electrical wiring not in compliance with electrical codes or SPECTRA user manual specifications, or failure to provide reasonable care and necessary maintenance as outlined in the user manual.
3. Warranty of all SPECTRA products applies to residential use only and is void when products are used in a nonresidential environment or installed outside the United States.

This warranty gives you specific legal rights, and you may also have other rights which vary from state to state. TO OBTAIN SERVICE please remove all batteries (if any) and pack the unit carefully and send it freight prepaid to SPECTRA at the address shown below. IF THE UNIT IS RETURNED WITHIN THE WARRANTY PERIOD shown above, please include a proof of purchase (dated cash register receipt) so that we may establish your eligibility for warranty service and repair of the unit without cost. Also include a note with a description explaining how the unit is defective. A customer service representative may need to contact you regarding the status of your repair, so please include your name, address, phone number and email address to expedite the process.

IF THE UNIT IS OUTSIDE THE WARRANTY PERIOD, please include a check for \$30.00 to cover the cost of repair, handling and return postage. All out of warranty returns must be sent prepaid.

It is recommended that you contact SPECTRA first at 1-800-777-5331 or by email at [custserv@spectrainl.com](mailto:custserv@spectrainl.com) for updated information on the unit requiring service. In some cases the model you have may be discontinued, and SPECTRA reserves the right to offer alternative options for repair or replacement.

SPECTRA MERCHANDISING INTERNATIONAL, INC.  
4230 North Normandy Avenue,  
Chicago, IL 60634, USA.  
1-800-777-5331

To register your product, visit the link on the website below to enter your information.  
<http://www.spectrainl.com/wform.htm>

0613

Printed in China